

Equipped with AEM® Dryflow™ Filter  
No Oil Required!

# **INSTALLATION INSTRUCTIONS**

## **PART NUMBER**

### **21-755C (GUNMETAL GRAY)**

---

2015

FORD

MUSTANG

3.7L

V-6

**Not legal for sale or use on any pollution controlled motor vehicle in California or states adopting California emission procedures. See [AEMIntakes.com](http://AEMIntakes.com) for CARB status on each part for a specific vehicle.**

ITEM NO.	PART NUMBER	DESCRIPTION	QTY.
1	08601K	HOSE CLAMP #48, BLACK ZINC	1
2	5-1046	HOSE, ADAPTER 3.00/3.50X2.5	1
3	08620K	HOSE CLAMP #56, BLACK ZINC	2
4	082628	VENT; 1/4 NPT TO QUICK DISCONNECT	1
5	08032	PLUG; 1/4 NPT, PLASTIC, BLACK	1
6	08047	VENT; STRT, 3/8"HOSE, 1/4"NPT, PLAS	1
7	8-4016	EDGE TRIM, 16"	2
8	2-1538C	INTAKE TUBE; 3.5" X 17"L, 21-755	1
9	1-2110	BOLT; HEX/FLANGE M6-1.0 X 12	1
10	08160	WASHER; 1"D X 1/4 HOLE FENDER	2
11	1228596	MOUNT, RUBBER M6 X 3/4" TALL M/F	1
12	077002	BOLT; M8-1.25 X 16MM, HEX, SS	1
13	559960	WASHER, 8MM SOFT MOUNT	1
14	21685	WASHER; 1" X .300 X .100 RUBBER	4
15	20-8542	HEAT SHIELD; 2015 FORD MUSTANG	1
16	444.460.04	NUT; M6 HEX SERRATED	1
17	102489	EDGE TRIM, 30"	1
18	21-2148DK	AIR FILTER KIT-3-1/2"FLG, 8-1/2"L	1

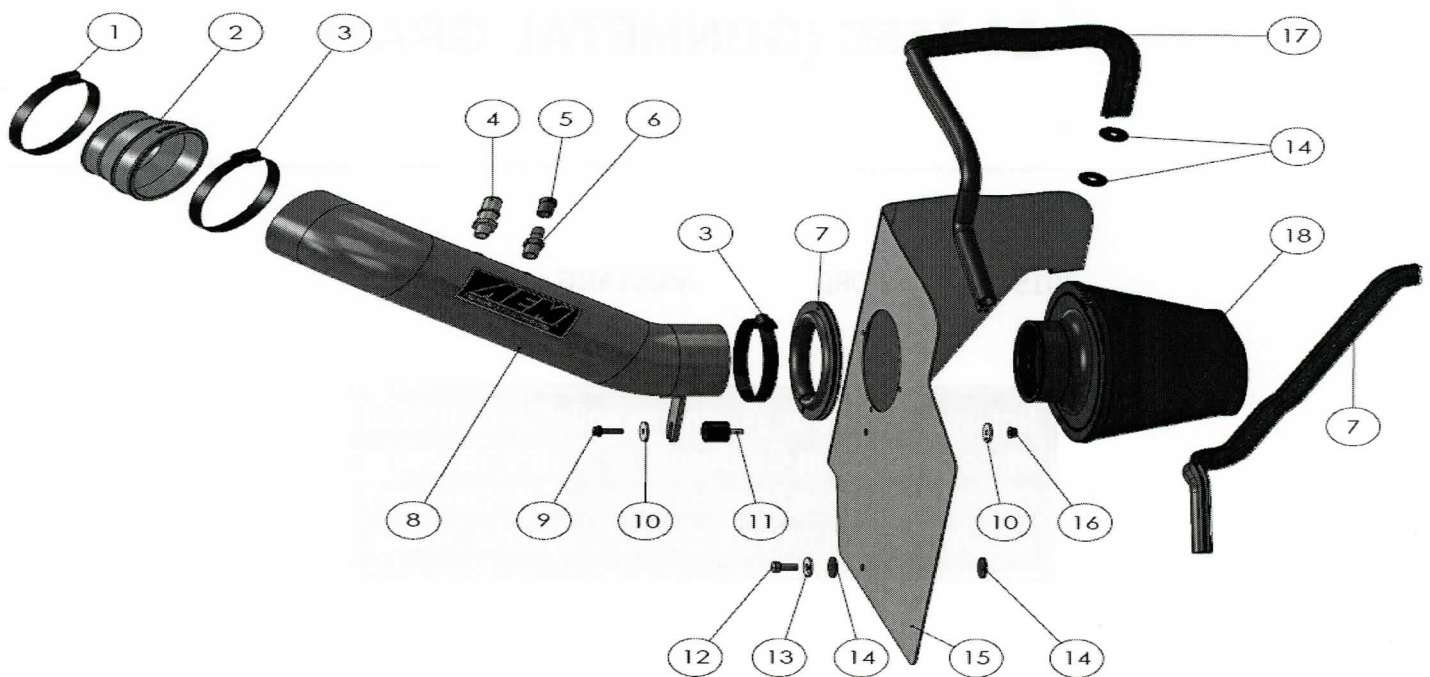

Read and understand these instructions **BEFORE** attempting to install this product. Failure to follow installation instructions and not using the provided hardware may damage the intake tube, throttle body and engine.

**Tools Needed:**

Screw Driver

Socket Driver

8mm Socket

10mm Socket

13mm Socket

14mm Socket

19mm Socket

**1. Preparing Vehicle**

- a. Make sure vehicle is parked on level surface.
- b. Set the parking brake.
- c. If engine has run in the past two hours, let it cool down.
- d. Disconnect negative battery terminal.
- e. Do not discard stock components after removal of the factory system.
- f. Open the air intake kit package and make sure all parts are included.

**2. Removal of stock system**

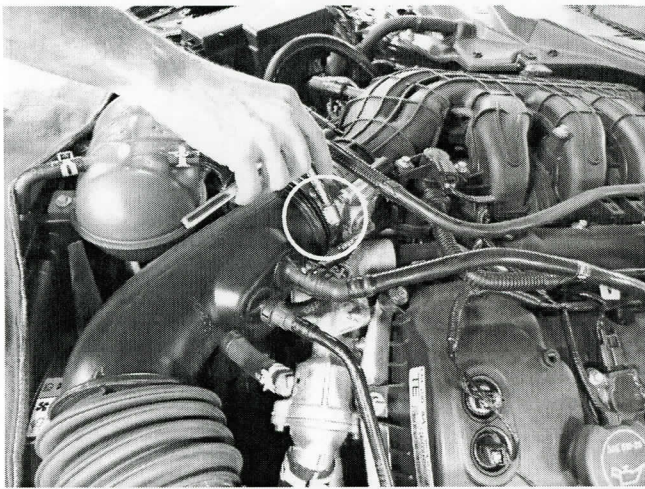

a. Loosen the hose clamp at the throttle body.

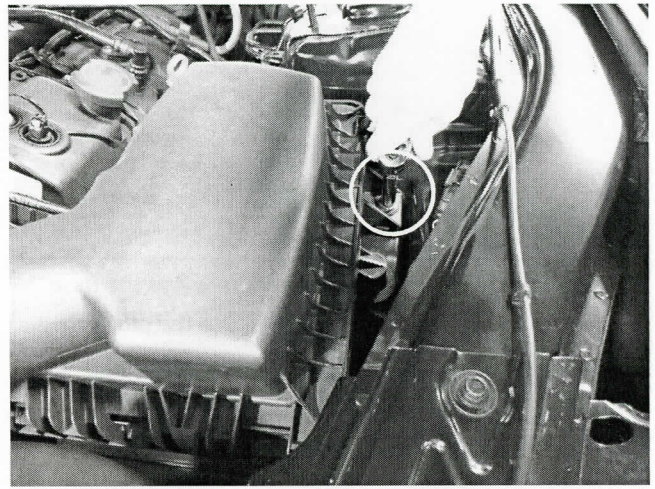

b. Remove the bolt securing the air box to the vehicle. This will be reused in step 3d.

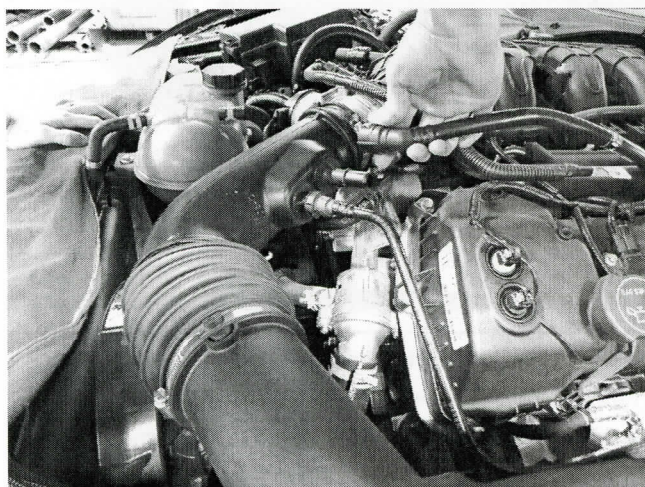

c. Unlatch the gray clip on the connector and pull the vent line from the stock intake tube.

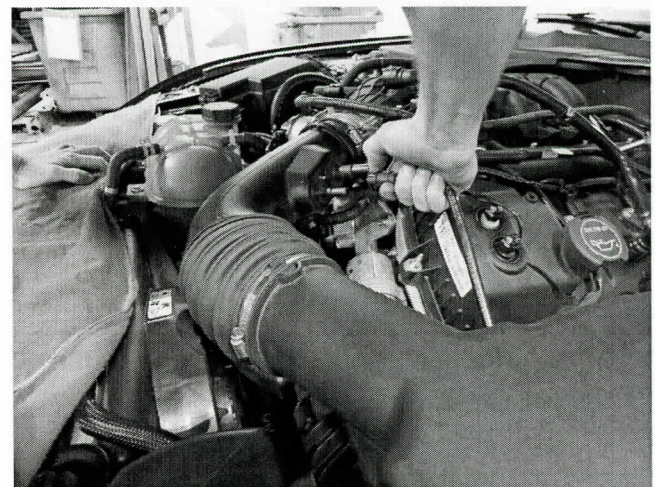

d. On automatic transmissions depress the gray clip and pull the second vent line from the stock intake. Manual transmissions will not have this vent line. Then remove the stock intake and air box from the vehicle.

### 3. Installation of AEM® intake system.

- a. When installing the intake system, do not completely tighten the hose clamps or mounting hardware until instructed to do so.

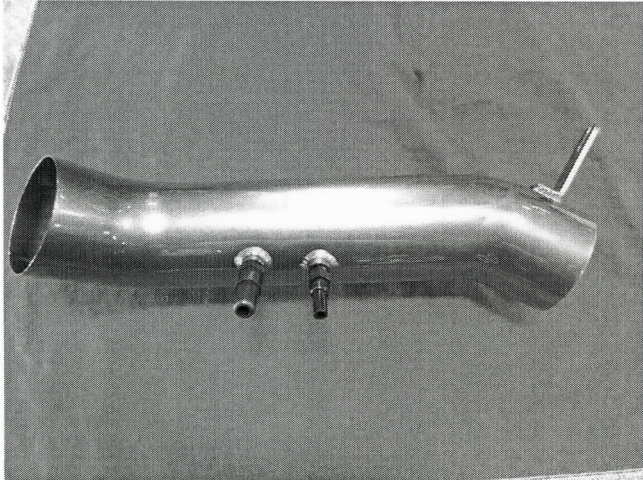

a. Install the two provided vent adapters into the tube as shown. Manual transmissions will use the plug provided instead of the vent adapter on the right side. Install finger tight, then a 1/4 turn with a wrench.

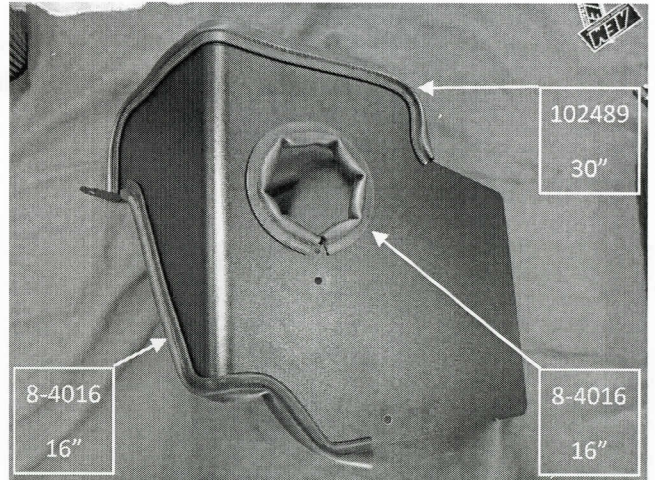

b. Install the provided edge trims onto the heat shield.



c. Assemble the heat shield as shown according to the component list on page 2.



d. Install the completed heat shield into the vehicle. With the bolt removed in step 2b, install the provided washers and tighten the heat shield to the vehicle.

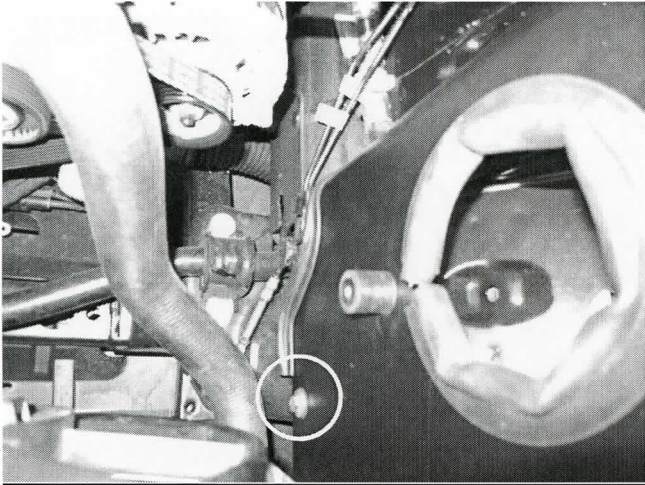

e. Using the provided M8 bolt and washer, tighten the heat shield to the vehicle where shown.

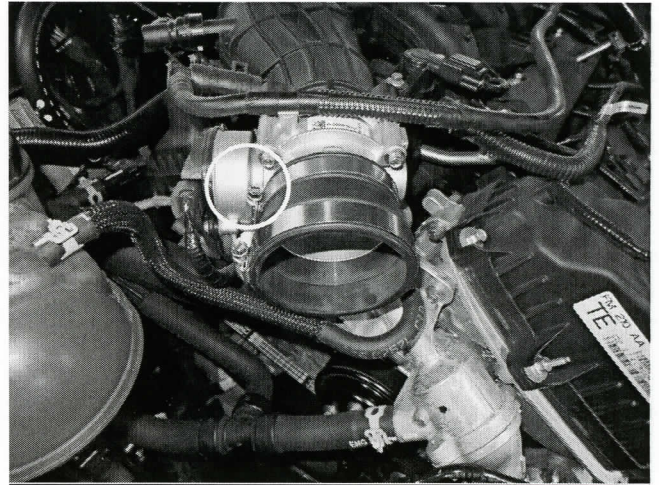

f. Install the coupler onto the throttle body with the provided hose clamps and tighten the one closest to the throttle body.

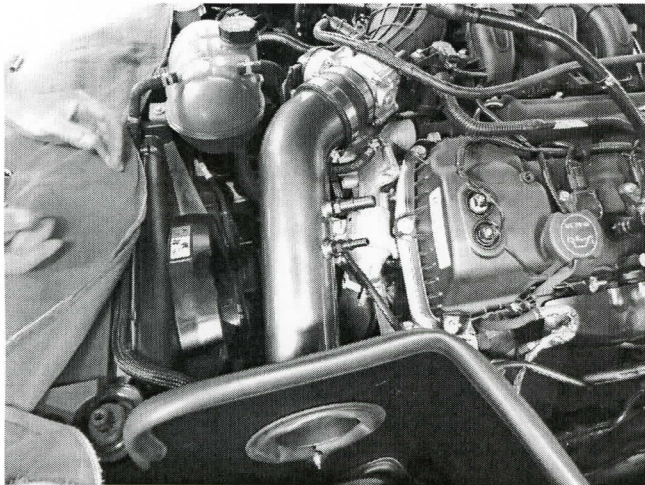

g. Install the AEM intake tube into the coupler and the heat shield opening.

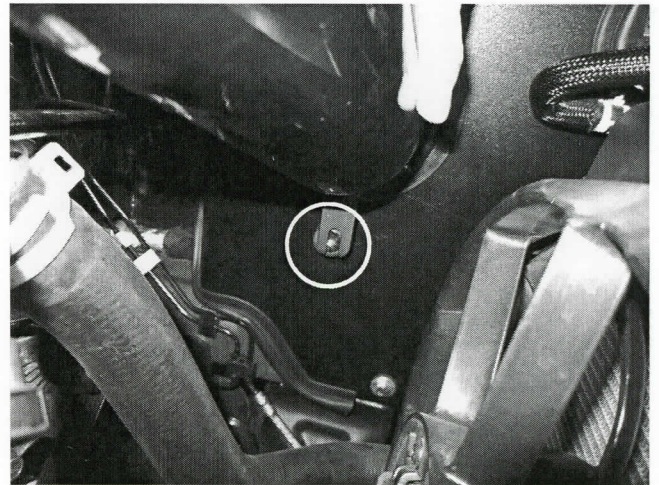

h. align the AEM intake bracket with the rubber mount.

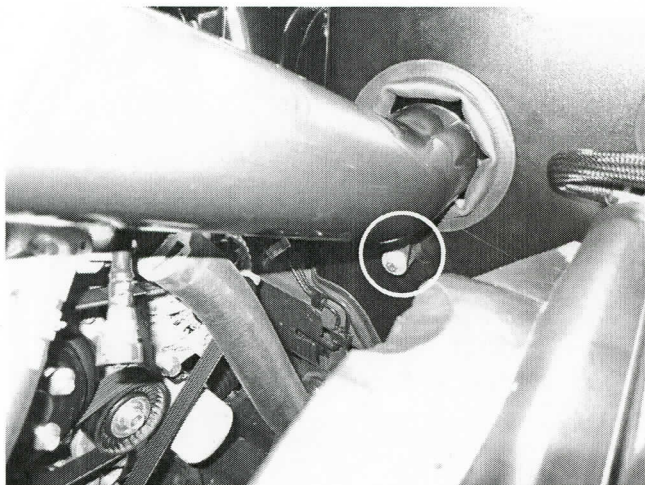

i. Install the provided bolt and washer and tighten the AEM intake tube bracket to the rubber mount.

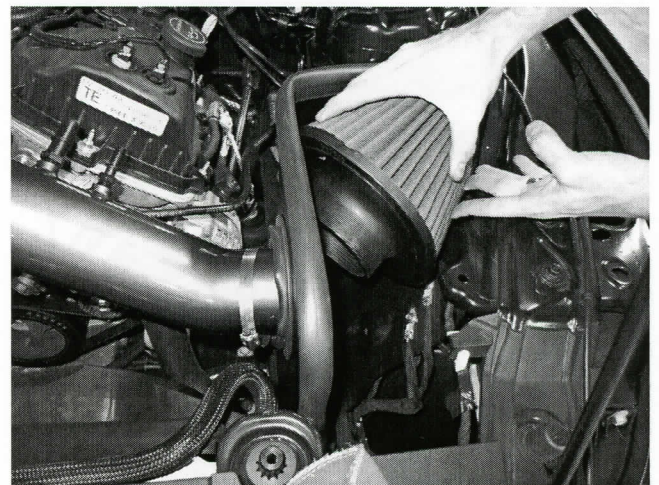

j. Install the hose clamp over the AEM intake tube and slide the AEM filter onto the tube as shown.

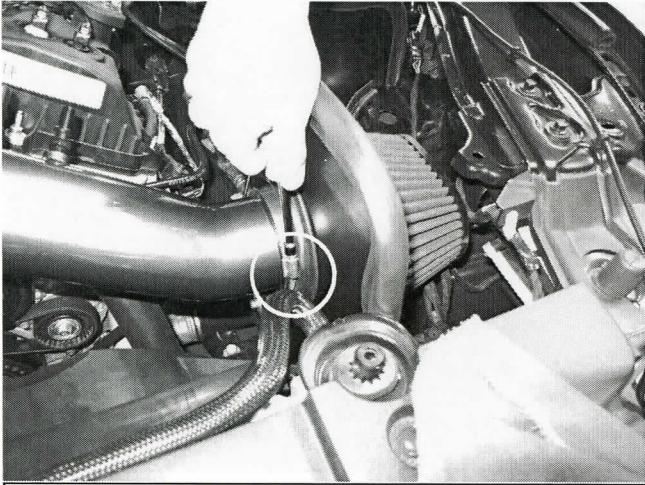

k. Slide the hose clamp over the filter and tighten at this time.

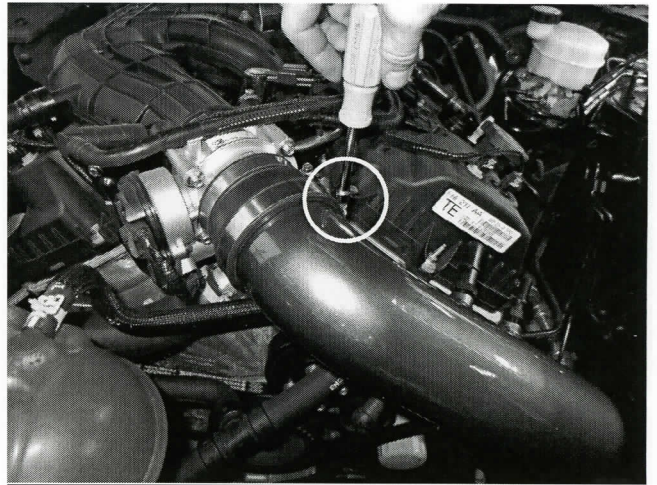

l. Tighten the other hose clamp furthest from the throttle body at this time.

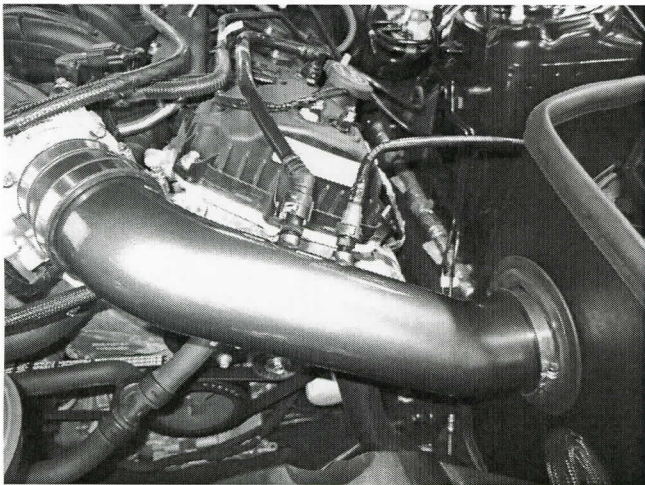

g. Slide the 2 vent lines onto the adapters, making sure you hear a click to confirm they are attached. Manual transmissions will only connect 1 vent line.

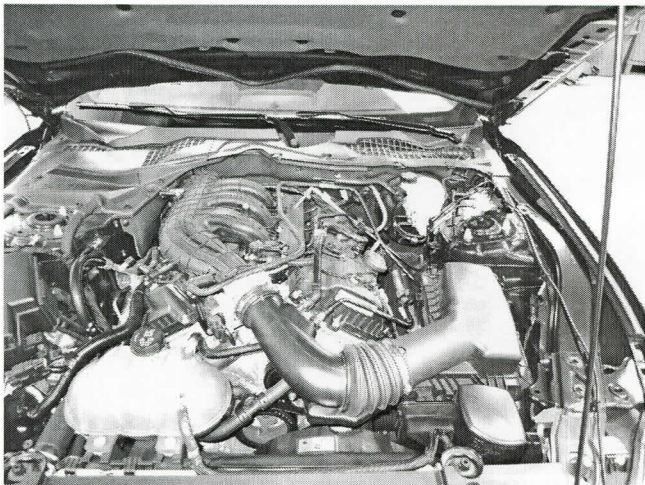

STOCK INTAKE INSTALLED

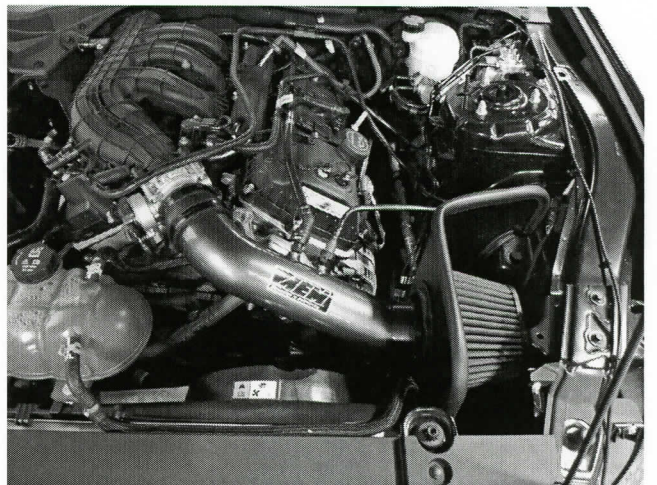

AEM INTAKE INSTALLED

#### 4. Reassemble Vehicle

- a. Position the inlet pipes for the best fitment. Be sure that the pipes or any other components do not contact any part of the vehicle.
- b. Check for proper hood clearance. Re-adjust pipes if necessary and re-tighten them.
- c. Inspect the engine bay for any loose tools and check that all fasteners that were moved or removed are properly tightened.
- d. Reconnect negative battery terminal and start engine. Let the vehicle idle for 3 minutes. Perform a final inspection before driving the vehicle.

#### 5. Service and Maintenance

- a. AEM Induction Systems requires cleaning the intake system's air filter element every 100,000 miles. When used in dusty or off-road environments, our filters will require cleaning more often. We recommend that you visually inspect your filter once every 25,000 miles to determine if the screen is still visible. When the screen is no longer visible some place on the filter element, it is time to clean it. To clean, purchase our Synthetic air filter cleaner, part number 1-1000 and follow the easy instructions.
- b. Use window cleaner to clean your powder coated AEM® intake tube.

**NOTE: DO NOT USE aluminum polish on powder coated AEM® intake tubes.**

For technical inquiries  
e-mail us at  
[sales@aemintakes.com](mailto:sales@aemintakes.com)  
or  
call us at  
800.992.3000

#### AEM Air Intake System Warranty Policy

AEM® warrants that its intake systems will last for the life of your vehicle. AEM® will not honor this warranty due to mechanical damage (i.e. improper installation or fitment), damage from misuse, accidents or flying debris. AEM® will not warrant its powder coating if the finish has been cleaned with a hydrocarbon-based solvent. The powder coating should only be cleaned with a mild soap and water solution. Proof of purchase of both the vehicle and AEM® intake system is required for redemption of a warranty claim.

This warranty is limited to the repair or replacement of the AEM® part. In no event shall this warranty exceed the original purchase price of the AEM® part nor shall AEM® be responsible for special, incidental or consequential damages or cost incurred due to the failure of this product. Warranty claims to AEM® must be transportation prepaid and accompanied with dated proof of purchase. This warranty applies only to the original purchaser of product and is nontransferable. Improper use or installation, use for racing, accident, abuse, unauthorized repairs or alterations voids this warranty. AEM® disclaims any liability for consequential damages due to breach of any written or implied warranty on all products manufactured by AEM®. Warranty returns will only be accepted by AEM® when accompanied by a valid Return Merchandise Authorization (RMA) number. Credit for defective products will be issued pending inspection. Product must be received by AEM® within 30 days of the date RMA is issued.

If you have a warranty issue, please call (800) 992-3000 and our customer service department will assist you. A proof of purchase is required for all AEM® warranty claims.

**Not legal for sale or use on any pollution controlled motor vehicle in California or states adopting California emission procedures. See AEMIntakes.com for CARB status on each part for a specific vehicle.**

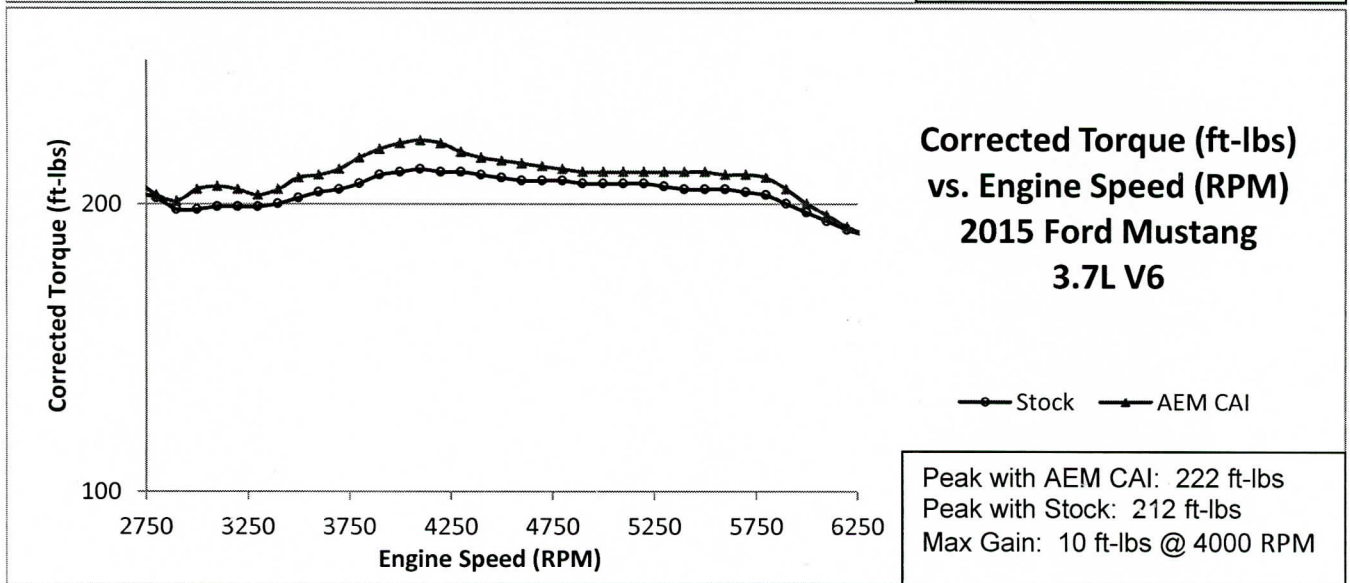
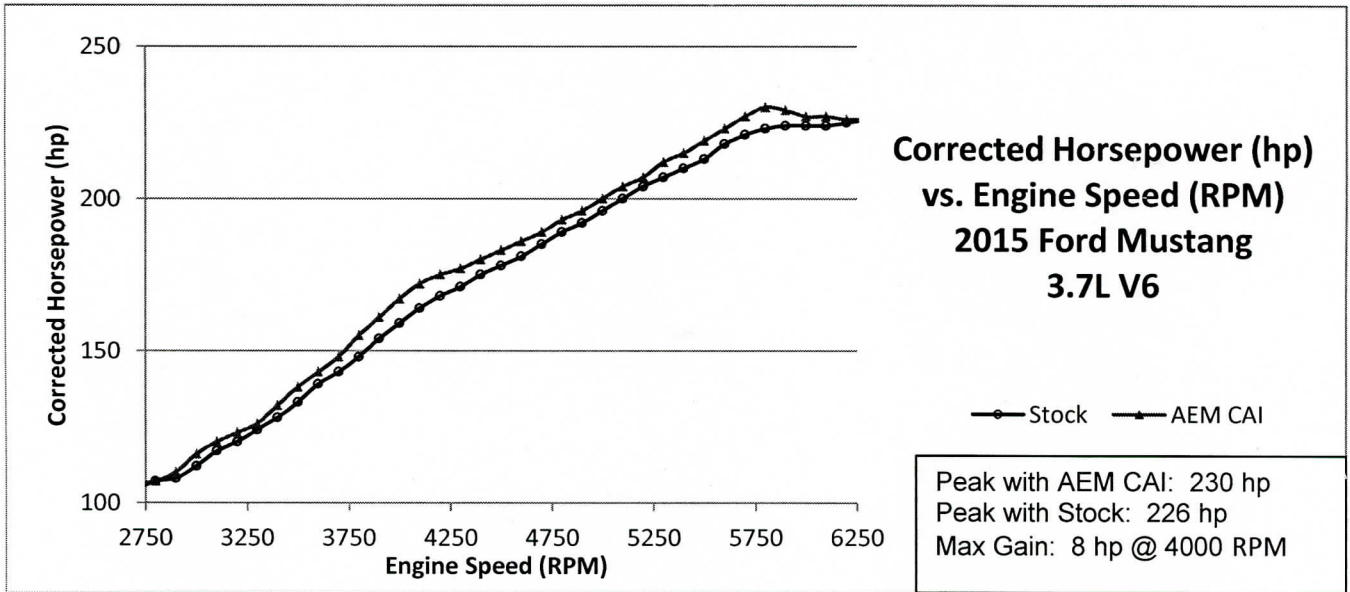

Run Title: Stock 2015 Ford Mustang 3.7L V6 Automatic

Run Notes: baseline run 2230 miles 2nd gear run

Run Date: 3/10/2015 9:25:05 am

Stock: 61 °F, 27.9 in-Hg, SAE: 1.04, Relative Humidity: 29 %

Run Title: AEM 2015 Ford Mustang 3.7L V6 Automatic

Run Notes: AEM 21-755C installed run 2230 miles 2nd gear run

Run Date: 3/10/2015 10:33:58 am

AEM: 73 °F, 27.9 in-Hg, SAE: 1.05, Relative Humidity: 12 %

Filter and vehicle specific data shown, results may vary for other models.

AEM21755