

# 2015+ Mustang GT Level 2 Performance Pack

Installation Instructions  
P/N: 421997



39555 Schoolcraft Rd, Plymouth MI, 48170 | 800.59.ROUSH

# 2015+ Mustang GT Level 2 Performance Pack

## Installation Instructions

P/N: 421997 (131550-PWRPK2-AA)

**Application:** 2015 Ford Mustang 5.0L Manual or Automatic Transmission

**Important Note:**

Before installing the ROUSH Performance Product, please read through the installation procedure and verify that all items are present. If you are missing hardware or have any questions, please contact ROUSH Performance at 1-800-59-ROUSH, 9:00 AM to 5:00 PM EST.

**TABLE OF CONTENTS**

Packing List for Mustang 5.0L Cold Air Intake.....3  
Equipment and Supplies Required.....3  
Limit of Liability Statement.....4  
Safety Precautions .....4  
Work Safely! .....4  
Section A – Removal .....5  
Section B – Installation.....7

**PACKING LIST FOR MUSTANG 5.0L COLD AIR INTAKE**

Description	Part Number	Quantity
Air Box	131550-9A612	1
Filter Tube	131550-12B579HC	1
Dirty Air Duct	1315-9F763	1
Clean Air Tube	131550-9B659	1
Filter with Clamp	131550-9601R	1
Hardware Kit	131550-CAKHWK	1
Bolt (M8 x 1.25 x 25)	W500224-S437	2
Grommet - Induction Resonance Tube Delete	W651016	1
Seal - Bulb Seal 25 mm CTL	131550-9C664	1

**EQUIPMENT AND SUPPLIES REQUIRED**

- 10 mm Socket
- Pliers
- Flat-head Screwdriver
- Trim Tool

**If you are missing any items, please call us toll free at 1-800-59-ROUSH.**

## LIMIT OF LIABILITY STATEMENT

The information contained in this publication was accurate and in effect at the time the publication was approved for printing and is subject to change without notice or liability. ROUSH Performance Products (RPP) reserves the right to revise the information presented herein or to discontinue the production of parts described at any time.

## SAFETY PRECAUTIONS



### **CAREFULLY READ THE IMPORTANT SAFETY PRECAUTIONS and WARNINGS BEFORE PROCEEDING WITH THE INSTALLATION!**

Appropriate disassembly, assembly methods and procedures are essential to ensure the personal safety of the individual performing the kit installation. Improper installation due to the failure to correctly follow these instructions could cause personal injury or death. Read each step of the installation manual carefully before starting the installation.

- Always wear safety glasses for eye protection.
- Place ignition switch in the OFF position.
- Always apply the parking brake when working on a vehicle.
- Block the front and rear tire surface to prevent unexpected vehicle movement.
- If working with a lift, always consult vehicle manual for correct lifting specifications.
- Operate the engine only in well-ventilated areas to avoid exposure to carbon monoxide.
- Do not smoke or use flammable items near or around the fuel system.
- Use chemicals and cleaners in well-ventilated areas.
- Batteries produce explosive gases, which can cause personal injury. Therefore, do not allow flames, sparks or flammable substances to come near the battery.
- Keeps hands and any other objects away from the radiator fan blades.
- Keep yourself and your clothing away from moving parts when the engine is running.
- Do not wear loose clothing or jewelry that can get caught in rotating parts or scratch surface finishes.
- Allow the engine, cooling system, brakes and exhaust to cool before working on a vehicle.

## **WORK SAFELY!**

Perform this installation on a good clean level surface for maximum safety and with the engine turned off.

## SECTION A – REMOVAL

The following section will guide you through the removal of the stock components. Special care should be taken to label fasteners and parts that are taken off during this procedure since many will be reused.

1. Cover both fenders with fender covers to protect the vehicle finish.
2. Disconnect the battery ground cable.
3. Disconnect the MAF sensor connector.



4. Loosen the clamp at the air box from the intake tube.



5. Release the two (2) latches holding the box lid to the lower box.

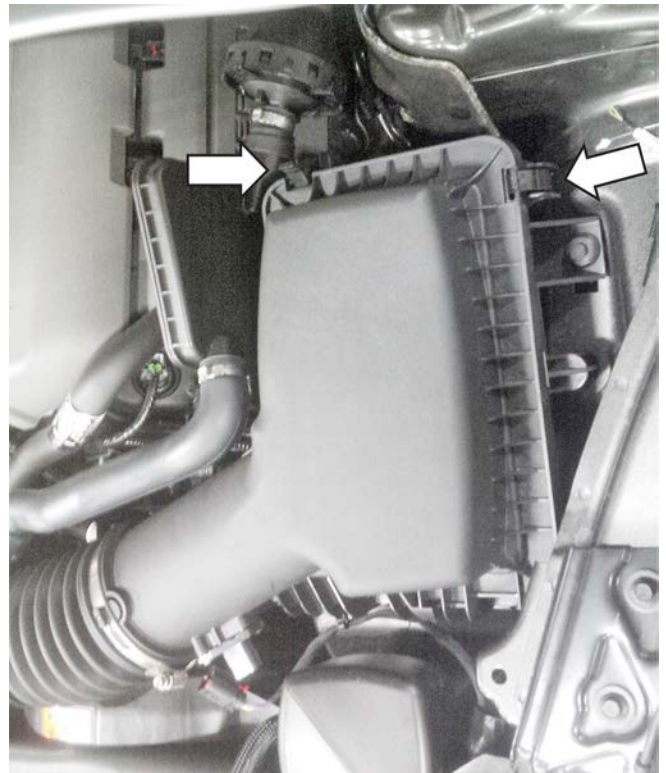

6. Remove the air box lid and filter. Retain the lid for use during installation.



7. Using the 10 mm socket, remove the bolt holding the air box to the inner fender. Retain the bolt as it will be used during installation.

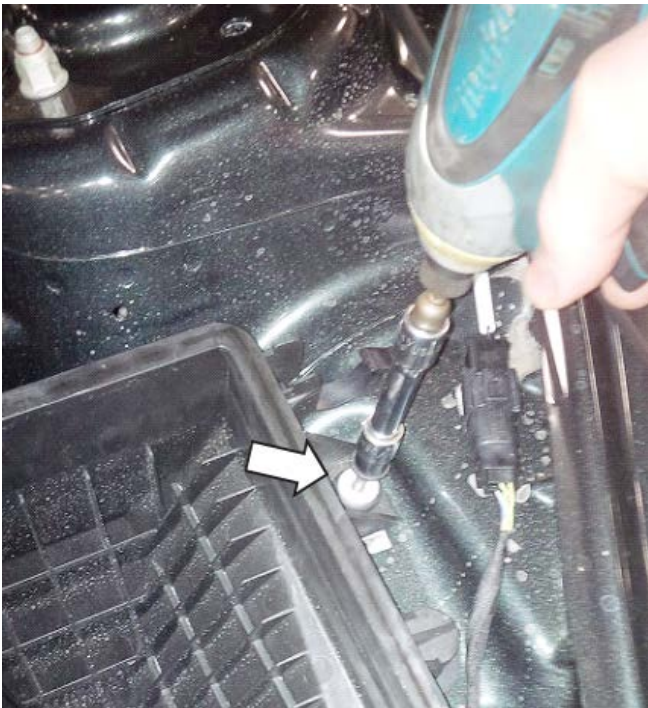

8. Remove the air box tray and dirty air inlet from the vehicle.

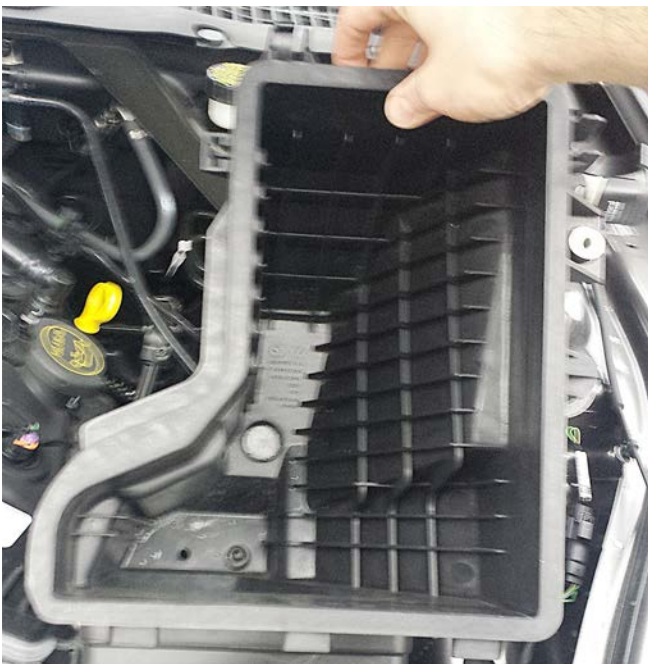

9. Remove the three (3) clips shown on the inner fender to give the slack needed in the wiring harness.

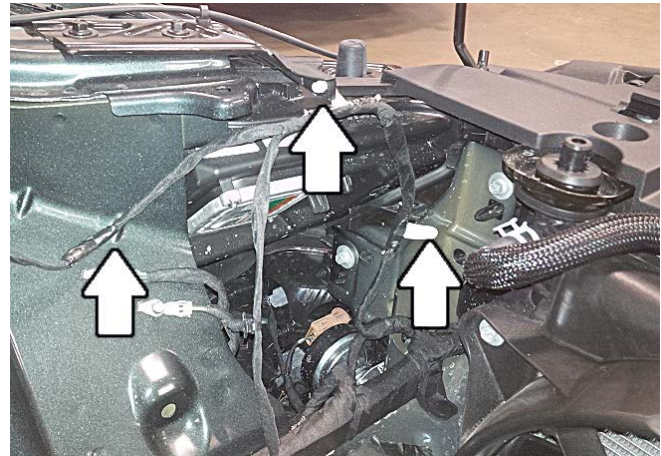

10. Remove the hose clamp and three (3) quick connect fittings from the clean air tube.



11. Using a 10 mm wrench or deep-well socket, remove the nut retaining the induction resonance tube to the firewall behind the driver side cylinder head.



12. Using a trim tool, pry up on the push pin retaining the induction resonance tube and remove the tube from the vehicle.



13. Remove the steel bushing followed by the two (2) rubber grommet from the stock air box tray. Retain these for use during installation.

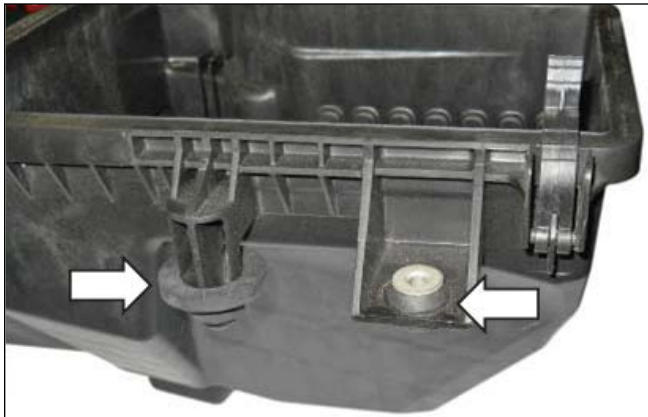

14. Remove the rubber isolator from the bottom of the stock air box tray and retain for use during installation.



## SECTION B – INSTALLATION

1. Install the resonance tube delete grommet (P/N: W651016) into the firewall.



2. Install the grommet and sleeve that was removed from the stock air box into the ROUSH air box (P/N: 131550-9A612). **TIP:** Install the rubber grommet first, then install the steel bushing.



3. Install the second grommet onto the air box (P/N: 131550-9A612).





4. Install the rubber isolator into the bottom of the air box (P/N: 131550-9A612).



5. Insert the dirty air inlet (P/N: 1315-9F763-A) into the air box (P/N: 131550-9A612).



6. Place the bulb seal (P/N: 131550-9C664) onto the top of the air box (P/N: 131550-9A612) and clip into the holes. Trim ends as required.



7. Insert the air box assembly into the vehicle.



8. Using a 10 mm socket and the bolt removed from the stock air box, attach the air box to the vehicle. Torque to 8 Nm.



9. Loosely attach the air filter (P/N: 131550-9601R) to the filter tube, leave the clamp loose so you can hide it once installed on the vehicle. Make sure the arrow on the filter is 90 degrees to the MAF sensor boss as shown.



10. Slide the filter tube assembly into the air box (P/N: 131550-9A612), making sure the sensor boss is pointed toward the front of the vehicle. Using a 10 mm socket, install the two (2) bolts (P/N: W500224). Torque to 10 Nm. Rotate the air filter clamp to a suitable location and torque to 3 Nm.



11. Install the clean air tube assembly (P/N: 131550-9R504) onto the throttle body first and then the filter tube. Tighten the clamps to 3 Nm.



12. Reconnect the three (3) hoses with quick connect fittings to the mating push-on bars.



13. Remove the MAF sensor from the factory air box by removing the two (2) T-15 torx screws.

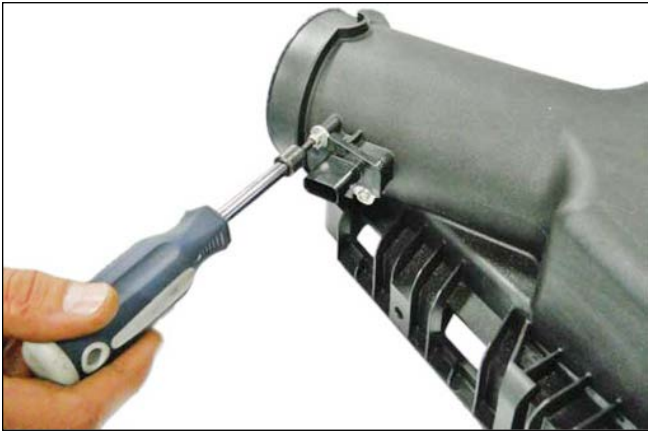

14. Re-install the MAF sensor into the ROUSH filter tube (P/N: 131550-12B579). Reattach the connector. Torque screws to 2 Nm.



## PCM FLASHING

Proceed with steps 1-2 if you have a SAE J2534 pass through device (e.g. Puma, VCM I, VCM II)

If you do not have a SAE J2534 device visit your local ROUSH Dealer or Performance Shop with the appropriate tools for PCM Calibration

1. If equipped with a SAE J2534 pass through device, refer to the RDT-CALIM manual found on our website, [rdt.roush.com](http://rdt.roush.com) The RDT-CALIM manual will guide you through the ROUSH Diagnostic Tool (RDT) software installation process and the ROUSH PCM flashing procedure detailed in RDT-CALIM.
2. Once the PCM has been successfully recalibrated, start the engine and check for unusual noises, dash service lights, and unusual operation. If problems are detected, immediately stop the engine or vehicle, diagnose and repair the problem.

# 2015+ Mustang V8 or V6 Exhaust Kit

Installation Instructions

P/N: 421834 (1315-5231ORR)

P/N: 421837 (1315V6-5231ORR)



**Important Note:**

Before installing your ROUSH Extreme Exhaust, please read through the installation procedure and verify that all items are present. If you are missing hardware or have any questions, please contact ROUSH Performance at 1-800-59-ROUSH, 9:00 AM to 5:00 PM weekdays.

**NOTE:** All illustrations in this manual are representative of the 2015+ Roush Performance Products Extreme Exhaust System.

**TABLE OF CONTENTS**

Packing List for Exhaust Kits.....3  
Equipment and Supplies Required.....3  
Limit of Liability Statement.....4  
Safety Precautions .....4  
Work Safely! .....4  
Original Exhaust System Removal .....5  
RPP Exhaust System Installation .....6

**PACKING LIST FOR V8 EXHAUST KIT 421834 (1315-5231ORR)**

Description	Part Number	Quantity
Muffler Assembly - LH	1315-5232ORR	1
Muffler Assembly - RH	1315-5230ORR	1
Exhaust Tips	1315-ORRTIP	2
Clamp - Muffler to Tip	10-0338	2
Clamp - Muffler to Mid-Pipe	94-0053	2

**PACKING LIST FOR V6 EXHAUST KIT 421837 (1315V6-5231ORR)**

Description	Part Number	Quantity
Muffler Assembly - LH	1315-5232ORR	1
Muffler Assembly - RH	1315-5230ORR	1
Exhaust Tips	1315-ORRTIP	2
Clamp - Muffler to Tip	10-0338	2
Clamp - Muffler to Mid-Pipe	94-0052	2

**EQUIPMENT AND SUPPLIES REQUIRED**

- 3/8" Drive Ratchet
- 3/8" Drive Extension 3"
- 15 mm Socket
- Spray Lubricant (Soapy Water/Glass Cleaner)
- Reciprocating Saw ("Sawzall")
- Marker

**If you are missing any items, please call us toll free at 1-800-59-ROUSH.**

## LIMIT OF LIABILITY STATEMENT

The information contained in this publication was accurate and in effect at the time the publication was approved for printing and is subject to change without notice or liability. ROUSH Performance Products (RPP) reserves the right to revise the information presented herein or to discontinue the production of parts described at any time.

## SAFETY PRECAUTIONS



### **CAREFULLY READ THE IMPORTANT SAFETY PRECAUTIONS and WARNINGS BEFORE PROCEEDING WITH THE INSTALLATION!**

Appropriate disassembly, assembly methods and procedures are essential to ensure the personal safety of the individual performing the kit installation. Improper installation due to the failure to correctly follow these instructions could cause personal injury or death. Read each step of the installation manual carefully before starting the installation.

- Always wear safety glasses for eye protection.
- Place ignition switch in the OFF position.
- Always apply the parking brake when working on a vehicle.
- Block the front and rear tire surface to prevent unexpected vehicle movement.
- If working with a lift, always consult vehicle manual for correct lifting specifications.
- Operate the engine only in well-ventilated areas to avoid exposure to carbon monoxide.
- Do not smoke or use flammable items near or around the fuel system.
- Use chemicals and cleaners in well-ventilated areas.
- Batteries produce explosive gases, which can cause personal injury. Therefore, do not allow flames, sparks or flammable substances to come near the battery.
- Keeps hands and any other objects away from the radiator fan blades.
- Keep yourself and your clothing away from moving parts when the engine is running.
- Do not wear loose clothing or jewelry that can get caught in rotating parts or scratch surface finishes.
- Allow the engine, cooling system, brakes and exhaust to cool before working on a vehicle.

## WORK SAFELY!

Perform this installation on a good clean level surface for maximum safety and with the engine turned off.

### ORIGINAL EXHAUST SYSTEM REMOVAL

1. On both sides of the vehicle's dual exhaust system, mark the LH and RH rear side of the exhaust pipes before they curve to the muffler as shown below, at the tangent of the curve.

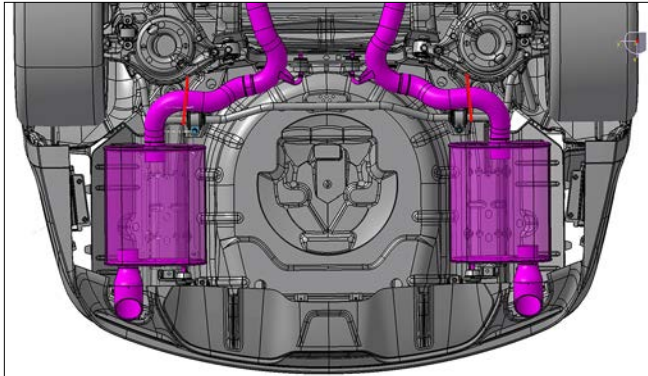

2. Cut the LH and RH exhaust pipes at the locations marked in step 1 using a reciprocating saw with a metal blade.



3. With the exhaust pipe cut, slide the hanger out of the rubber mount and remove the muffler/tip assembly from the vehicle.



**NOTE:** The disassembly process is identical for the left and right sides of the OEM exhaust. This concludes the disassembly process for the OEM axle-back exhaust.

### **WARNING**

Use extreme caution during installation. Torque all fasteners according to manufacturer's torque values and tightening sequence. **DO NOT** use air impact tools to tighten fasteners on ROUSH Performance Products Exhaust Systems. Use of such tools may result in bent flanges or gasket contact areas leading to exhaust leaks which may result in serious personal injury or death.



### RPP EXHAUST SYSTEM INSTALLATION

1. Remove any protective shipping covering from both the RH and LH mufflers.
2. Slide the provided band clamps over the original exhaust pipe, one clamp on each side (LH and RH).



3. Insert the Roush muffler hanger into the mount at the rear of the vehicle, and then slide the new pipe over the existing pipe.

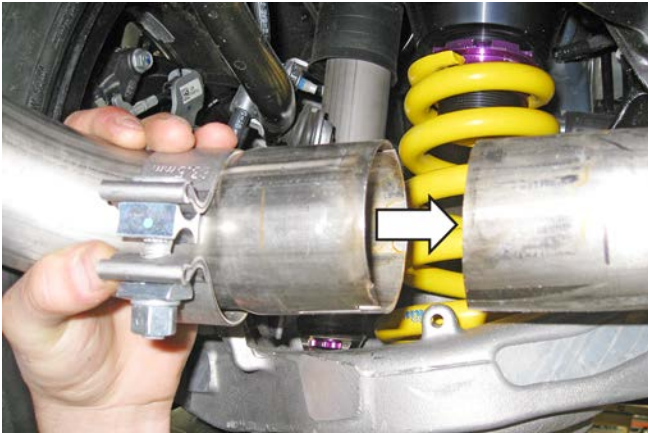

4. Slide the band clamp (94-0053/94-0052) over the joint in step 3 and torque the 15 mm bolt to 30 Nm.



5. Place the band clamp (10-0338) over the exhaust tip and slide the tip over the muffler. Torque the band clamp to 30 Nm once the tip is in position.



6. Check the exhaust system for correct clearance under the vehicle and also for tip alignment as shown below. If alignment is off, loosen the required band clamp, adjust, and re-torque the band clamp.



7. Once the desired position and alignment have been achieved, make sure all band clamps are torqued to 30 Nm.



8. Before starting the vehicle, make sure to check all wires, hoses, brake lines, body parts, tires and any other components for safe clearance from the exhaust system.
9. Start the vehicle and check for any leaks. If any leaks are found, determine the cause (such as loose or incorrectly positioned clamp) and repair as necessary.

**Congratulations!!!** You have completed the installation of the ROUSH Performance Products, Ford Mustang Exhaust Kit. It is recommended that you save all parts removed from the vehicle during the installation of this kit.

